

MENGELKING

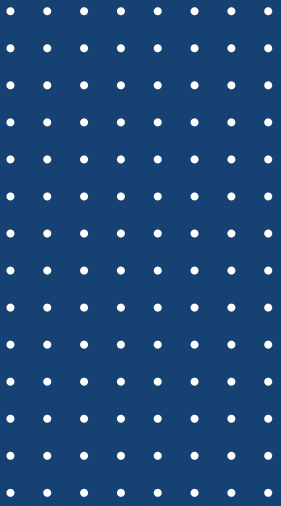

M8 Series

Overmoulded Connectors

Male cable

Product figure



Scale diagram

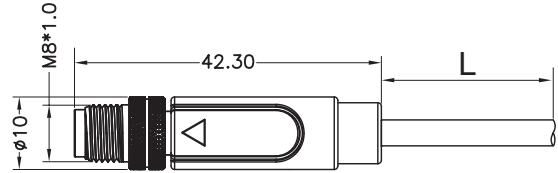

Contact layout (Front view)

3pins

A



4pins

A



4pins

A



6pins

A



8pins

A

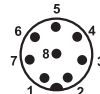

5pins

B

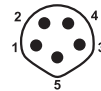

4pins

D

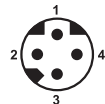

Order data

Contacts	Coding	Order No
3pins	A	M08A03/MA3/BN/OE
4pins	A	M08A04/MA3/BN/OE
	A(fool-proof)	M08104/MA3/BN/OE
	D	M08D04/MA3/BN/OE
5pins	B	M08B05/MA3/BN/OE
6pins	A	M08A06/MA3/BN/OE
8pins	A	M08A08/MA3/BN/OE

Specifications

Number of contacts	3	4 A-coding	4 D-coding	5	6	8
Termination	moulded on cable					
Wire gauge	0.14/0.25/0.34 mm ² / (26/24/22 AWG)					
Operating temperature	-25°C ~ +80°C					
Mechanical operation	> 100 mating cycles					
Rated voltage	50V AC / 60V DC		60V	30V		
Rated current (40°C)	3A		4A	3A	1.5A	
Protection degree	IP67/IP68					
Contact resistance	< 10mΩ					
Insulation resistance	≥ 100MΩ					
Pin contact	CuZn					
Socket contact	CuSn					
Contact plating	Au					

Female cable

Product figure



Scale diagram

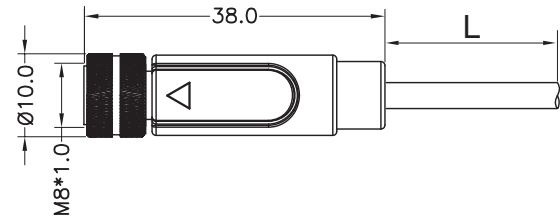

Contact layout (Front view)

3pins

A



4pins

A



4pins

A



6pins

A



8pins

A

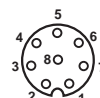

5pins

B

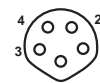

4pins

D

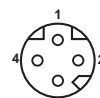

Order data

Contacts	Coding	Order No
3pins	A	M08A03/FA3/BN/OE
4pins	A	M08A04/FA3/BN/OE
	A(fool-proof)	M08104/FA3/BN/OE
	D	M08D04/FA3/BN/OE
5pins	B	M08B05/FA3/BN/OE
6pins	A	M08A06/FA3/BN/OE
8pins	A	M08A08/FA3/BN/OE

Specifications

Number of contacts	3	4 A-coding	4 D-coding	5	6	8
Termination	moulded on cable					
Wire gauge	0.14/0.25/0.34 mm ² / (26/24/22 AWG)					
Operating temperature	-25°C ~ +80°C					
Mechanical operation	> 100 mating cycles					
Rated voltage	50V AC / 60V DC		60V	30V		
Rated current (40°C)	3A		4A	3A	1.5A	
Protection degree	IP67/IP68					
Contact resistance	< 10mΩ					
Insulation resistance	≥ 100MΩ					
Pin contact	CuZn					
Socket contact	CuSn					
Contact plating	Au					

Male cable (90°)

Product figure



Scale diagram

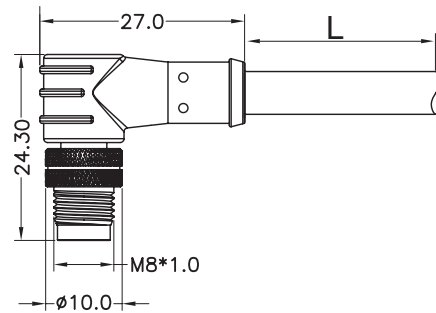

Contact layout (Front view)

3pins

A



4pins

A



4pins

A



6pins

A



8pins

A



5pins

B



4pins

D



Order data

Contacts	Coding	Order No
3pins	A	M08A03/MA2/BN/OE
4pins	A	M08A04/MA2/BN/OE
	A(fool-proof)	M08104/MA2/BN/OE
	D	M08D04/MA2/BN/OE
5pins	B	M08B05/MA2/BN/OE
6pins	A	M08A06/MA2/BN/OE
8pins	A	M08A08/MA2/BN/OE

Specifications

Number of contacts	3	4 A-coding	4 D-coding	5	6	8
Termination	moulded on cable					
Wire gauge	0.14/0.25/0.34 mm ² / (26/24/22 AWG)					
Operating temperature	-25°C ~ +80°C					
Mechanical operation	> 100 mating cycles					
Rated voltage	50V AC / 60V DC		60V	30V		
Rated current (40°C)	3A		4A	3A	1.5A	
Protection degree	IP67/IP68					
Contact resistance	< 10mΩ					
Insulation resistance	≥ 100MΩ					
Pin contact	CuZn					
Socket contact	CuSn					
Contact plating	Au					

Female cable (90°)

Product figure



Scale diagram

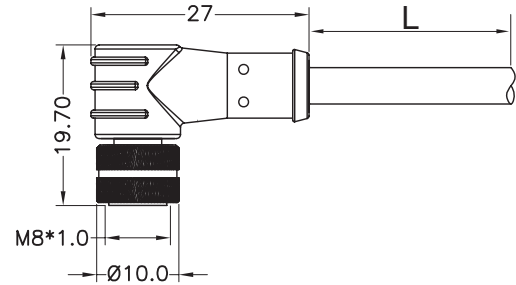

Contact layout (Front view)

3pins

A



4pins

A



4pins

A



6pins

A



8pins

A

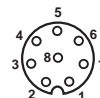

5pins

B



4pins

D

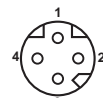

Order data

Contacts	Coding	Order No
3pins	A	M08A03/FA2/BN/OE
4pins	A	M08A04/FA2/BN/OE
	A(fool-proof)	M08104/FA2/BN/OE
	D	M08D04/FA2/BN/OE
5pins	B	M08B05/FA2/BN/OE
6pins	A	M08A06/FA2/BN/OE
8pins	A	M08A08/FA2/BN/OE

Specifications

Number of contacts	3	4 A-coding	4 D-coding	5	6	8
Termination	moulded on cable					
Wire gauge	0.14/0.25/0.34 mm ² / (26/24/22 AWG)					
Operating temperature	-25°C ~ +80°C					
Mechanical operation	> 100 mating cycles					
Rated voltage	50V AC / 60V DC		60V	30V		
Rated current (40°C)	3A		4A	3A	1.5A	
Protection degree	IP67/IP68					
Contact resistance	< 10mΩ					
Insulation resistance	≥ 100MΩ					
Pin contact	CuZn					
Socket contact	CuSn					
Contact plating	Au					

Female cable (with LED PNP)

Product figure



Scale diagram

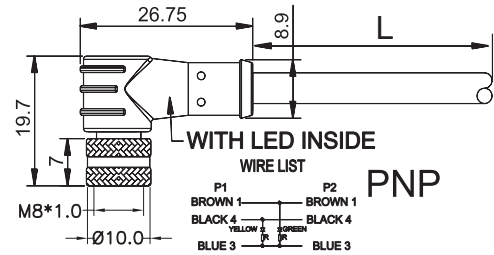

Contact layout (Front view)

3pins

4pins

4pins

A

A

A



Order data

Contacts	Coding	Order No
3pins	A	M08A03/MA4/BN/OE
4pins	A	M08A04/MA4/BN/OE
	A(fool-proof)	M08104/MA4/BN/OE

Specifications

Number of contacts	3	4
Termination	moulded on cable	
Wire gauge	0.14/0.25/0.34 mm ² / (26/24/22 AWG)	
Operating temperature	-25°C ~ +80°C	
Mechanical operation	> 100 mating cycles	
Rated voltage	50V AC / 60V DC	
Rated current (40°C)	3A	
Protection degree	IP67/IP68	
Contact resistance	< 10mΩ	
Insulation resistance	≥100MΩ	
Pin contact	CuZn	
Socket contact	CuSn	
Contact plating	Au	

Male cable (with LED PNP)

Product figure



Scale diagram

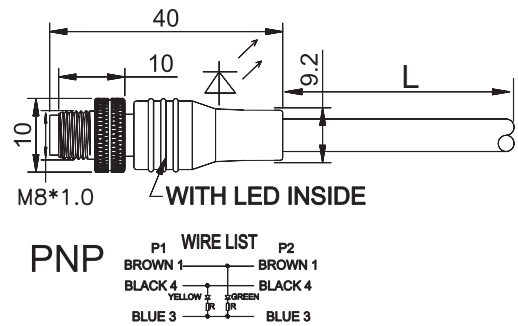

Contact layout (Front view)

3pins

4pins

4pins

A

A

A



Order data

Contacts	Coding	Order No
3pins	A	M08A03/MA6/BN/OE
4pins	A	M08A04/MA6/BN/OE
	A(fool-proof)	M08104/MA6/BN/OE

Specifications

Number of contacts	3	4
Termination	moulded on cable	
Wire gauge	0.14/0.25/0.34 mm ² / (26/24/22 AWG)	
Operating temperature	-25°C ~ +80°C	
Mechanical operation	> 100 mating cycles	
Rated voltage	50V AC / 60V DC	
Rated current (40°C)	3A	
Protection degree	IP67/IP68	
Contact resistance	< 10mΩ	
Insulation resistance	≥100MΩ	
Pin contact	CuZn	
Socket contact	CuSn	
Contact plating	Au	

Male cable

Product figure



Scale diagram

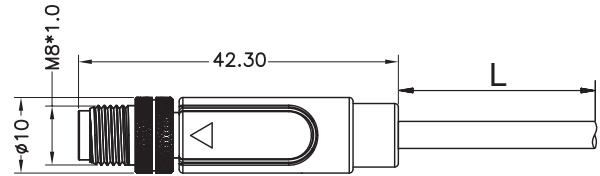

Contact layout (Front view)

3pins

A

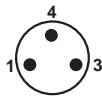

4pins

A

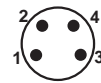

Circuit diagram

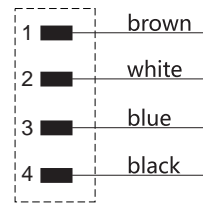
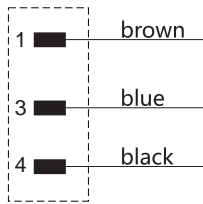

Order No

Cable length	Contacts	Wire diameter	PVC		PUR	
			black	gray	black	gray
1.5M	3pins	0.25mm ²	M08A03/MA3/BN/OE/01/1500	M08A03/MA3/BN/OE/06/1500	M08A03/MA3/BN/OE/21/1500	M08A03/MA3/BN/OE/26/1500
	4pins	0.25mm ²	M08A04/MA3/BN/OE/01/1500	M08A04/MA3/BN/OE/06/1500	M08A04/MA3/BN/OE/21/1500	M08A04/MA3/BN/OE/26/1500
3.0M	3pins	0.25mm ²	M08A03/MA3/BN/OE/01/3000	M08A03/MA3/BN/OE/06/3000	M08A03/MA3/BN/OE/21/3000	M08A03/MA3/BN/OE/26/3000
	4pins	0.25mm ²	M08A04/MA3/BN/OE/01/3000	M08A04/MA3/BN/OE/06/3000	M08A04/MA3/BN/OE/21/3000	M08A04/MA3/BN/OE/26/3000
5.0M	3pins	0.25mm ²	M08A03/MA3/BN/OE/01/5000	M08A03/MA3/BN/OE/06/5000	M08A03/MA3/BN/OE/21/5000	M08A03/MA3/BN/OE/26/5000
	4pins	0.25mm ²	M08A04/MA3/BN/OE/01/5000	M08A04/MA3/BN/OE/06/5000	M08A04/MA3/BN/OE/21/5000	M08A04/MA3/BN/OE/26/5000
7.5M	3pins	0.25mm ²	M08A03/MA3/BN/OE/01/7500	M08A03/MA3/BN/OE/06/7500	M08A03/MA3/BN/OE/21/7500	M08A03/MA3/BN/OE/26/7500
	4pins	0.25mm ²	M08A04/MA3/BN/OE/01/7500	M08A04/MA3/BN/OE/06/7500	M08A04/MA3/BN/OE/21/7500	M08A04/MA3/BN/OE/26/7500
10M	3pins	0.25mm ²	M08A03/MA3/BN/OE/01/10M0	M08A03/MA3/BN/OE/06/10M0	M08A03/MA3/BN/OE/21/10M0	M08A03/MA3/BN/OE/26/10M0
	4pins	0.25mm ²	M08A04/MA3/BN/OE/01/10M0	M08A04/MA3/BN/OE/06/10M0	M08A04/MA3/BN/OE/21/10M0	M08A04/MA3/BN/OE/26/10M0

Specification

Number of contacts	3	4
Rated voltage	50V AC / 60V DC	
Rated current (40°C)	3A	
Protection degree	IP67/IP68	
Operating temperature	-25°C ~ +80°C	
Cable OD	4.6mm	4.6~5.0mm

Male cable

Product figure



Scale diagram

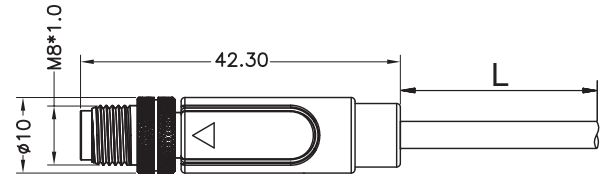

Contact layout (Front view)

3pins

A

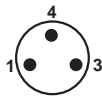

Circuit diagram

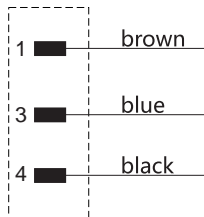

Order No

Cable length	Contacts	Wire diameter	PUR
			black
1.5M	3pins	0.34mm ²	M08A03/MA3/BN/OE/22/1500
3.0M	3pins	0.34mm ²	M08A03/MA3/BN/OE/22/3000
5.0M	3pins	0.34mm ²	M08A03/MA3/BN/OE/22/5000
7.5M	3pins	0.34mm ²	M08A03/MA3/BN/OE/22/7500
10M	3pins	0.34mm ²	M08A03/MA3/BN/OE/22/10M0

Specification

Number of contacts	3
Rated voltage	50V AC / 60V DC
Rated current (40°C)	3A
Protection degree	IP67/IP68
Operating temperature	-25°C ~ +80°C
Cable OD	4.5~5.0mm

Female cable

Product figure



Scale diagram

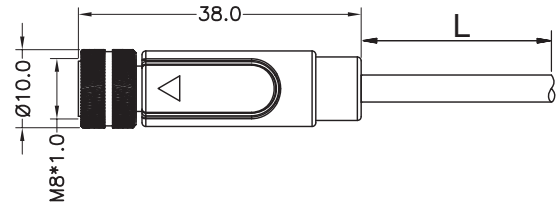

Contact layout (Front view)

3pins

A

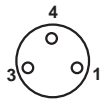

4pins

A

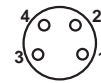

Circuit diagram

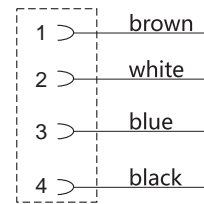
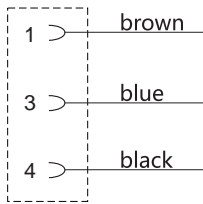

Order No

Cable length	Contacts	Wire diameter	PVC		PUR	
			black	gray	black	gray
1.5M	3pins	0.25mm ²	M08A03/FA3/BN/OE/01/1500	M08A03/FA3/BN/OE/06/1500	M08A03/FA3/BN/OE/21/1500	M08A03/FA3/BN/OE/26/1500
	4pins	0.25mm ²	M08A04/FA3/BN/OE/01/1500	M08A04/FA3/BN/OE/06/1500	M08A04/FA3/BN/OE/21/1500	M08A04/FA3/BN/OE/26/1500
3.0M	3pins	0.25mm ²	M08A03/FA3/BN/OE/01/3000	M08A03/FA3/BN/OE/06/3000	M08A03/FA3/BN/OE/21/3000	M08A03/FA3/BN/OE/26/3000
	4pins	0.25mm ²	M08A04/FA3/BN/OE/01/3000	M08A04/FA3/BN/OE/06/3000	M08A04/FA3/BN/OE/21/3000	M08A04/FA3/BN/OE/26/3000
5.0M	3pins	0.25mm ²	M08A03/FA3/BN/OE/01/5000	M08A03/FA3/BN/OE/06/5000	M08A03/FA3/BN/OE/21/5000	M08A03/FA3/BN/OE/26/5000
	4pins	0.25mm ²	M08A04/FA3/BN/OE/01/5000	M08A04/FA3/BN/OE/06/5000	M08A04/FA3/BN/OE/21/5000	M08A04/FA3/BN/OE/26/5000
7.5M	3pins	0.25mm ²	M08A03/FA3/BN/OE/01/7500	M08A03/FA3/BN/OE/06/7500	M08A03/FA3/BN/OE/21/7500	M08A03/FA3/BN/OE/26/7500
	4pins	0.25mm ²	M08A04/FA3/BN/OE/01/7500	M08A04/FA3/BN/OE/06/7500	M08A04/FA3/BN/OE/21/7500	M08A04/FA3/BN/OE/26/7500
10M	3pins	0.25mm ²	M08A03/FA3/BN/OE/01/10M0	M08A03/FA3/BN/OE/06/10M0	M08A03/FA3/BN/OE/21/10M0	M08A03/FA3/BN/OE/26/10M0
	4pins	0.25mm ²	M08A04/FA3/BN/OE/01/10M0	M08A04/FA3/BN/OE/06/10M0	M08A04/FA3/BN/OE/21/10M0	M08A04/FA3/BN/OE/26/10M0

Specification

Number of contacts	3	4
Rated voltage	50V AC / 60V DC	
Rated current (40°C)	3A	
Protection degree	IP67/IP68	
Operating temperature	-25°C ~ +80°C	
Cable OD	4.6mm	4.6~5.0mm

Female cable

Product figure



Scale diagram

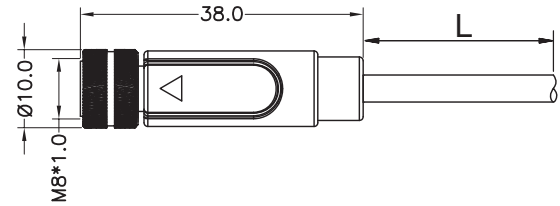

Contact layout (Front view)

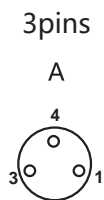

Circuit diagram

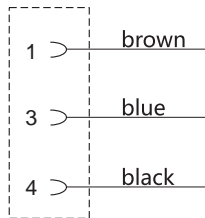

Order No

Cable length	Contacts	Wire diameter	PVC
			gray
1.5M	3pins	0.34mm ²	M08A03/MA3/BN/OE/07/1500
3.0M	3pins	0.34mm ²	M08A03/MA3/BN/OE/07/3000
5.0M	3pins	0.34mm ²	M08A03/MA3/BN/OE/07/5000
7.5M	3pins	0.34mm ²	M08A03/MA3/BN/OE/07/7500
10M	3pins	0.34mm ²	M08A03/MA3/BN/OE/07/10M0

Specification

Number of contacts	3
Rated voltage	50V AC / 60V DC
Rated current (40°C)	3A
Protection degree	IP67/IP68
Operating temperature	-25°C ~ +80°C
Cable OD	4.5~5.0mm

Male cable (90°)

Product figure



Scale diagram

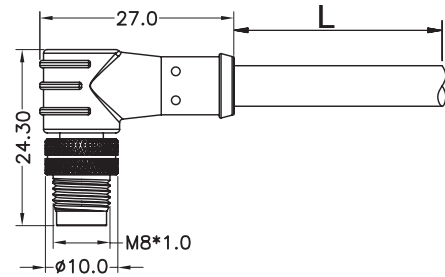

Contact layout (Front view)

3pins

A

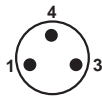

4pins

A

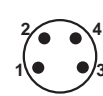

Circuit diagram

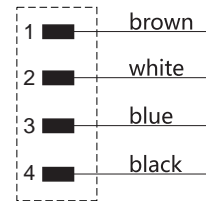
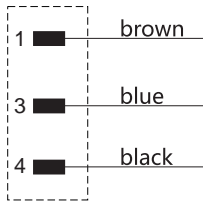

Order No

Cable length	Contacts	Wire diameter	PVC		PUR	
			black	gray	black	gray
1.5M	3pins	0.25mm ²	M08A03/MA2/BN/OE/01/1500	M08A03/MA2/BN/OE/06/1500	M08A03/MA2/BN/OE/21/1500	M08A03/MA2/BN/OE/26/1500
	4pins	0.25mm ²	M08A04/MA2/BN/OE/01/1500	M08A04/MA2/BN/OE/06/1500	M08A04/MA2/BN/OE/21/1500	M08A04/MA2/BN/OE/26/1500
3.0M	3pins	0.25mm ²	M08A03/MA2/BN/OE/01/3000	M08A03/MA2/BN/OE/06/3000	M08A03/MA2/BN/OE/21/3000	M08A03/MA2/BN/OE/26/3000
	4pins	0.25mm ²	M08A04/MA2/BN/OE/01/3000	M08A04/MA2/BN/OE/06/3000	M08A04/MA2/BN/OE/21/3000	M08A04/MA2/BN/OE/26/3000
5.0M	3pins	0.25mm ²	M08A03/MA2/BN/OE/01/5000	M08A03/MA2/BN/OE/06/5000	M08A03/MA2/BN/OE/21/5000	M08A03/MA2/BN/OE/26/5000
	4pins	0.25mm ²	M08A04/MA2/BN/OE/01/5000	M08A04/MA2/BN/OE/06/5000	M08A04/MA2/BN/OE/21/5000	M08A04/MA2/BN/OE/26/5000
7.5M	3pins	0.25mm ²	M08A03/MA2/BN/OE/01/7500	M08A03/MA2/BN/OE/06/7500	M08A03/MA2/BN/OE/21/7500	M08A03/MA2/BN/OE/26/7500
	4pins	0.25mm ²	M08A04/MA2/BN/OE/01/7500	M08A04/MA2/BN/OE/06/7500	M08A04/MA2/BN/OE/21/7500	M08A04/MA2/BN/OE/26/7500
10M	3pins	0.25mm ²	M08A03/MA2/BN/OE/01/10M0	M08A03/MA2/BN/OE/06/10M0	M08A03/MA2/BN/OE/21/10M0	M08A03/MA2/BN/OE/26/10M0
	4pins	0.25mm ²	M08A04/MA2/BN/OE/01/10M0	M08A04/MA2/BN/OE/06/10M0	M08A04/MA2/BN/OE/21/10M0	M08A04/MA2/BN/OE/26/10M0

Specification

Number of contacts	3	4
Rated voltage	50V AC / 60V DC	
Rated current (40°C)	3A	
Protection degree	IP67/IP68	
Operating temperature	-25°C ~ +80°C	
Cable OD	4.6mm	4.6~5.0mm

Female cable (90°)

Product figure



Scale diagram

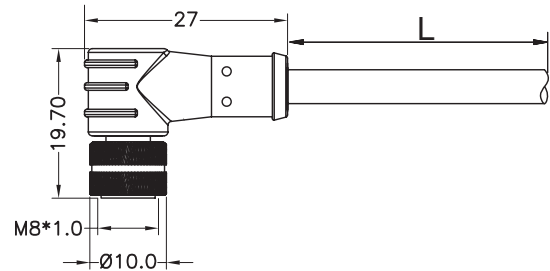

Contact layout (Front view)

3pins

A

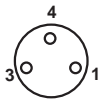

4pins

A

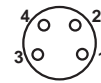

Circuit diagram

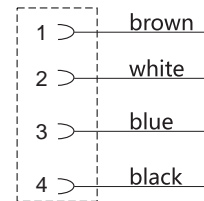
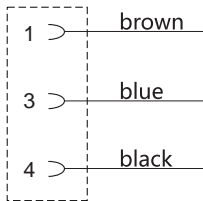

Order No

Cable length	Contacts	Wire diameter	PVC		PUR	
			black	gray	black	gray
1.5M	3pins	0.25mm ²	M08A03/FA2/BN/OE/01/1500	M08A03/FA2/BN/OE/06/1500	M08A03/FA2/BN/OE/21/1500	M08A03/FA2/BN/OE/26/1500
	4pins	0.25mm ²	M08A04/FA2/BN/OE/01/1500	M08A04/FA2/BN/OE/06/1500	M08A04/FA2/BN/OE/21/1500	M08A04/FA2/BN/OE/26/1500
3.0M	3pins	0.25mm ²	M08A03/FA2/BN/OE/01/3000	M08A03/FA2/BN/OE/06/3000	M08A03/FA2/BN/OE/21/3000	M08A03/FA2/BN/OE/26/3000
	4pins	0.25mm ²	M08A04/FA2/BN/OE/01/3000	M08A04/FA2/BN/OE/06/3000	M08A04/FA2/BN/OE/21/3000	M08A04/FA2/BN/OE/26/3000
5.0M	3pins	0.25mm ²	M08A03/FA2/BN/OE/01/5000	M08A03/FA2/BN/OE/06/5000	M08A03/FA2/BN/OE/21/5000	M08A03/FA2/BN/OE/26/5000
	4pins	0.25mm ²	M08A04/FA2/BN/OE/01/5000	M08A04/FA2/BN/OE/06/5000	M08A04/FA2/BN/OE/21/5000	M08A04/FA2/BN/OE/26/5000
7.5M	3pins	0.25mm ²	M08A03/FA2/BN/OE/01/7500	M08A03/FA2/BN/OE/06/7500	M08A03/FA2/BN/OE/21/7500	M08A03/FA2/BN/OE/26/7500
	4pins	0.25mm ²	M08A04/FA2/BN/OE/01/7500	M08A04/FA2/BN/OE/06/7500	M08A04/FA2/BN/OE/21/7500	M08A04/FA2/BN/OE/26/7500
10M	3pins	0.25mm ²	M08A03/FA2/BN/OE/01/10M0	M08A03/FA2/BN/OE/06/10M0	M08A03/FA2/BN/OE/21/10M0	M08A03/FA2/BN/OE/26/10M0
	4pins	0.25mm ²	M08A04/FA2/BN/OE/01/10M0	M08A04/FA2/BN/OE/06/10M0	M08A04/FA2/BN/OE/21/10M0	M08A04/FA2/BN/OE/26/10M0

Specification

Number of contacts	3	4
Rated voltage	50V AC / 60V DC	
Rated current (40°C)	3A	
Protection degree	IP67/IP68	
Operating temperature	-25°C ~ +80°C	
Cable OD	4.6mm	4.6~5.0mm

Male cable (with LED PNP)

Product figure



Scale diagram

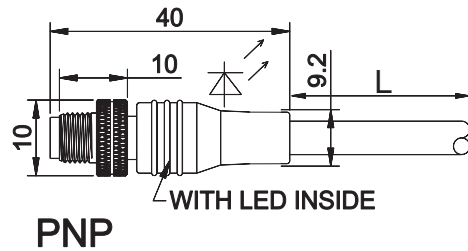

Contact layout (Front view)



Circuit diagram

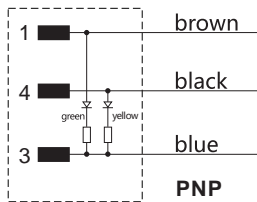

Order No

Cable length	Contacts	0.25mm ²
1.5M	3pins	M08A03/MA6/BN/OE/01/1500
3.0M	3pins	M08A03/MA6/BN/OE/01/3000
5.0M	3pins	M08A03/MA6/BN/OE/01/5000
7.5M	3pins	M08A03/MA6/BN/OE/01/7500
10M	3pins	M08A03/MA6/BN/OE/01/10M0

Specification

Number of contacts	3
Rated voltage	50V AC / 60V DC
Rated current (40°C)	3A
Protection degree	IP67/IP68
Operating temperature	-25°C ~ +80°C
Cable OD	4.6mm

Male cable (with LED NPN)

Product figure



Scale diagram

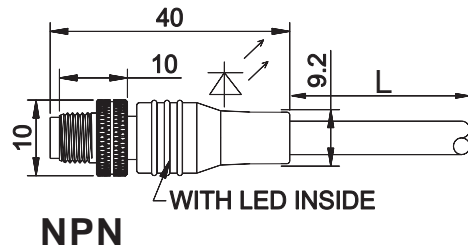

Contact layout (Front view)

4pins

A



Circuit diagram

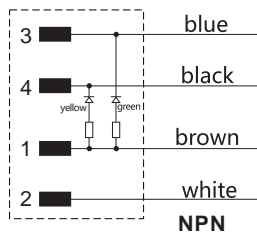

Order No/订货号

Cable length	Contacts	0.25mm ²
1.5M	4pins	M08A03/MA3/BN/OE/01/1500
3.0M	4pins	M08A03/MA3/BN/OE/01/3000
5.0M	4pins	M08A03/MA3/BN/OE/01/5000
7.5M	4pins	M08A03/MA3/BN/OE/01/7500
10M	4pins	M08A03/MA3/BN/OE/01/10M0

Specification

Number of contacts	4
Rated voltage	50V AC / 60V DC
Rated current (40°C)	3A
Protection degree	IP67/IP68
Operating temperature	-25°C ~ +80°C
Cable OD	4.6~5.0mm

Female cable (with LED PNP)

Product figure



Scale diagram

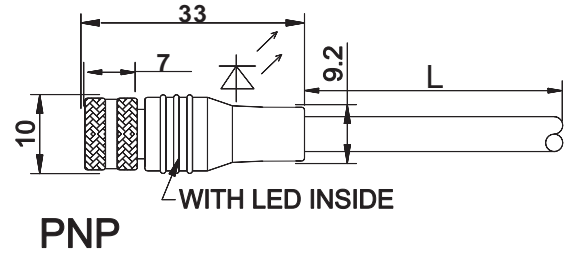

Contact layout (Front view)

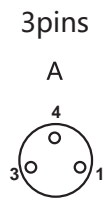

Circuit diagram

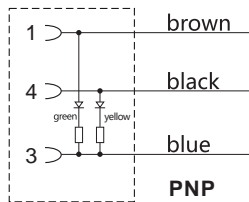

Order No

Cable length	Contacts	0.25mm ²
1.5M	3pins	M08A03/FA6/BN/OE/01/1500
3.0M	3pins	M08A03/FA6/BN/OE/01/3000
5.0M	3pins	M08A03/FA6/BN/OE/01/5000
7.5M	3pins	M08A03/FA6/BN/OE/01/7500
10M	3pins	M08A03/FA6/BN/OE/01/10M0

Specification

Number of contacts	3
Rated voltage	50V AC / 60V DC
Rated current (40°C)	3A
Protection degree	IP67/IP68
Operating temperature	-25°C ~ +80°C
Cable OD	4.6mm

Female cable (with LED NPN)

Product figure



Scale diagram

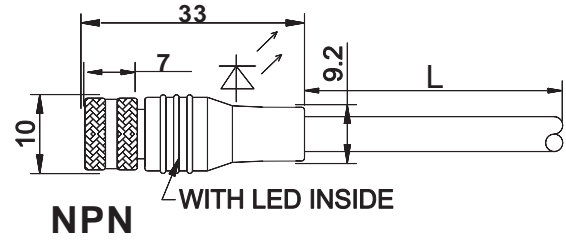

Contact layout (Front view)

4pins

A



Circuit diagram

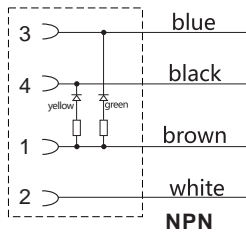

Order No

Cable length	Contacts	0.25mm ²
1.5M	4pins	M08A04/FA7/BN/OE/01/1500
3.0M	4pins	M08A04/FA7/BN/OE/01/3000
5.0M	4pins	M08A04/FA7/BN/OE/01/5000
7.5M	4pins	M08A04/FA7/BN/OE/01/7500
10M	4pins	M08A04/FA7/BN/OE/01/10M0

Specification

Number of contacts	4
Rated voltage	50V AC / 60V DC
Rated current (40°C)	3A
Protection degree	IP67/IP68
Operating temperature	-25°C ~ +80°C
Cable OD	4.6~5.0mm

Male cable (90° with LED PNP)

Product figure



Scale diagram

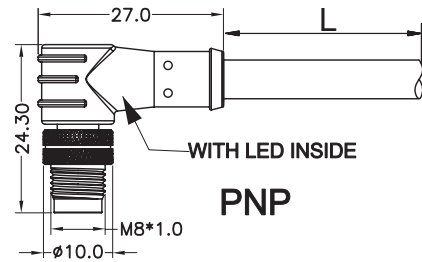

Contact layout (Front view)



Circuit diagram

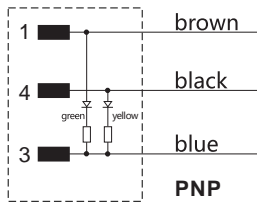

Order No

Cable length	Contacts	0.25mm ²
1.5M	3pins	M08A03/MA4/BN/OE/01/1500
3.0M	3pins	M08A03/MA4/BN/OE/01/3000
5.0M	3pins	M08A03/MA4/BN/OE/01/5000
7.5M	3pins	M08A03/MA4/BN/OE/01/7500
10M	3pins	M08A03/MA4/BN/OE/01/10M0

Specification

Number of contacts	3
Rated voltage	50V AC / 60V DC
Rated current (40°C)	3A
Protection degree	IP67/IP68
Operating temperature	-25°C ~ +80°C
Cable OD	4.6mm

Male cable (90° with LED NPN)

Product figure



Scale diagram

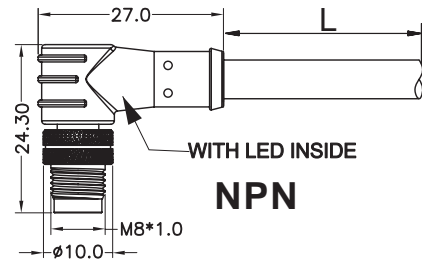

Contact layout (Front view)

4pins

A



Circuit diagram

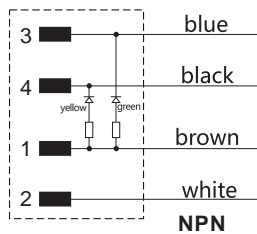

Order No

Cable length	Contacts	0.25mm ²
1.5M	4pins	M08A04/MA5/BN/OE/01/1500
3.0M	4pins	M08A04/MA5/BN/OE/01/3000
5.0M	4pins	M08A04/MA5/BN/OE/01/5000
7.5M	4pins	M08A04/MA5/BN/OE/01/7500
10M	4pins	M08A04/MA5/BN/OE/01/10M0

Specification

Number of contacts	4
Rated voltage	50V AC / 60V DC
Rated current (40°C)	3A
Protection degree	IP67/IP68
Operating temperature	-25°C ~ +80°C
Cable OD	4.6~5.0mm

Female cable (90° with LED PNP)

Product figure



Scale diagram

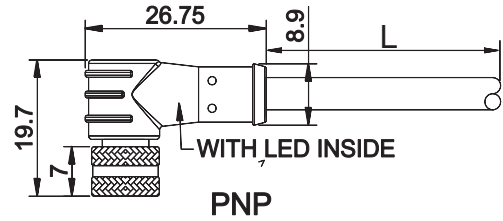

Contact layout (Front view)

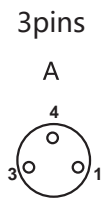

Circuit diagram

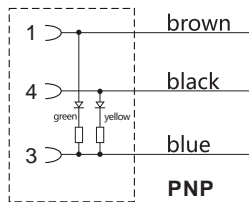

Order No

Cable length	Contacts	0.25mm ²
1.5M	3pins	M08A03/FA4/BN/OE/01/1500
3.0M	3pins	M08A03/FA4/BN/OE/01/3000
5.0M	3pins	M08A03/FA4/BN/OE/01/5000
7.5M	3pins	M08A03/FA4/BN/OE/01/7500
10M	3pins	M08A03/FA4/BN/OE/01/10M0

Specification

Number of contacts	3
Rated voltage	50V AC / 60V DC
Rated current (40°C)	3A
Protection degree	IP67/IP68
Operating temperature	-25°C ~ +80°C
Cable OD	4.6mm

Female cable (90° with LED NPN)

Product figure



Scale diagram

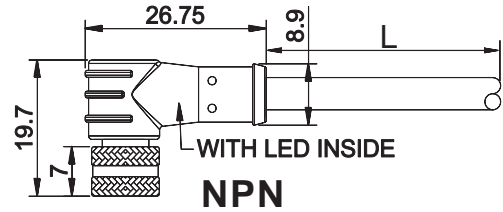

Contact layout (Front view)

4pins

A



Circuit diagram

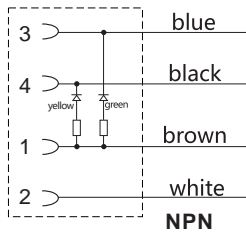

Order No

Cable length	Contacts	0.25mm ²
1.5M	4pins	M08A04/FA5/BN/OE/01/1500
3.0M	4pins	M08A04/FA5/BN/OE/01/3000
5.0M	4pins	M08A04/FA5/BN/OE/01/5000
7.5M	4pins	M08A04/FA5/BN/OE/01/7500
10M	4pins	M08A04/FA5/BN/OE/01/10M0

Specification

Number of contacts/芯数	4
Rated voltage	50V AC / 60V DC
Rated current (40°C)	3A
Protection degree	IP67/IP68
Operating temperature	-25°C ~ +80°C
Cable OD	4.6~5.0mm

Male cable (with shield)

Product figure



Scale diagram

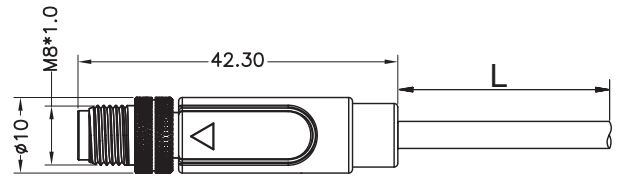

Contact layout (Front view)

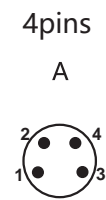

Circuit diagram

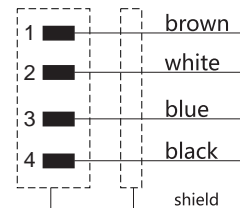
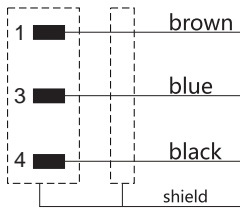

Order No

Cable length	Contacts	Wire diameter	PVC+AEB		PUR+AEB	
			black	gray	black	gray
1.5M	3pins	0.25mm ²	M08A03/MB4/BN/OE/31/1500	M08A03/MB4/BN/OE/36/1500	M08A03/MB4/BN/OE/41/1500	M08A03/MB4/BN/OE/46/1500
	4pins	0.25mm ²	M08A04/MB4/BN/OE/31/1500	M08A04/MB4/BN/OE/36/1500	M08A04/MB4/BN/OE/41/1500	M08A04/MB4/BN/OE/46/1500
3.0M	3pins	0.25mm ²	M08A03/MB4/BN/OE/31/3000	M08A03/MB4/BN/OE/36/3000	M08A03/MB4/BN/OE/41/3000	M08A03/MB4/BN/OE/46/3000
	4pins	0.25mm ²	M08A04/MB4/BN/OE/31/3000	M08A04/MB4/BN/OE/36/3000	M08A04/MB4/BN/OE/41/3000	M08A04/MB4/BN/OE/46/3000
5.0M	3pins	0.25mm ²	M08A03/MB4/BN/OE/31/5000	M08A03/MB4/BN/OE/36/5000	M08A03/MB4/BN/OE/41/5000	M08A03/MB4/BN/OE/46/5000
	4pins	0.25mm ²	M08A04/MB4/BN/OE/31/5000	M08A04/MB4/BN/OE/36/5000	M08A04/MB4/BN/OE/41/5000	M08A04/MB4/BN/OE/46/5000
7.5M	3pins	0.25mm ²	M08A03/MB4/BN/OE/31/7500	M08A03/MB4/BN/OE/36/7500	M08A03/MB4/BN/OE/41/7500	M08A03/MB4/BN/OE/46/7500
	4pins	0.25mm ²	M08A04/MB4/BN/OE/31/7500	M08A04/MB4/BN/OE/36/7500	M08A04/MB4/BN/OE/41/7500	M08A04/MB4/BN/OE/46/7500
10M	3pins	0.25mm ²	M08A03/MB4/BN/OE/31/10M0	M08A03/MB4/BN/OE/36/10M0	M08A03/MB4/BN/OE/41/10M0	M08A03/MB4/BN/OE/46/10M0
	4pins	0.25mm ²	M08A04/MB4/BN/OE/31/10M0	M08A04/MB4/BN/OE/36/10M0	M08A04/MB4/BN/OE/41/10M0	M08A04/MB4/BN/OE/46/10M0

Specification

	3	4
Number of contacts	3	4
Rated voltage	50V AC / 60V DC	
Rated current (40°C)	3A	
Protection degree	IP67/IP68	
Operating temperature	-25°C ~ +80°C	
Cable OD	4.6mm	4.6~5.0mm

Female cable (with shield)

Product figure



Scale diagram

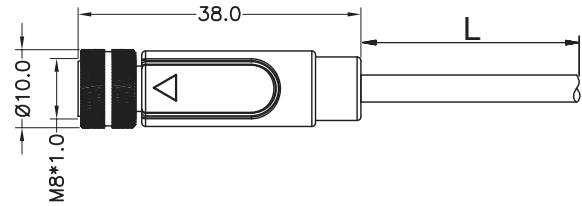

Contact layout (Front view)

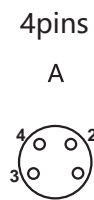
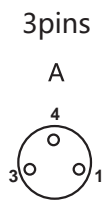

Circuit diagram

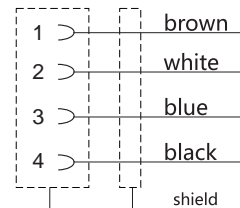
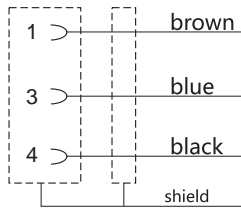

Order No

Cable length	Contacts	Wire diameter	PVC+AEB		PUR+AEB	
			black	gray	black	gray
1.5M	3pins	0.25mm ²	M08A03/FB4/BN/OE/31/1500	M08A03/FB4/BN/OE/36/1500	M08A03/FB4/BN/OE/41/1500	M08A03/FB4/BN/OE/46/1500
	4pins	0.25mm ²	M08A04/FB4/BN/OE/31/1500	M08A04/FB4/BN/OE/36/1500	M08A04/FB4/BN/OE/41/1500	M08A04/FB4/BN/OE/46/1500
3.0M	3pins	0.25mm ²	M08A03/FB4/BN/OE/31/3000	M08A03/FB4/BN/OE/36/3000	M08A03/FB4/BN/OE/41/3000	M08A03/FB4/BN/OE/46/3000
	4pins	0.25mm ²	M08A04/FB4/BN/OE/31/3000	M08A04/FB4/BN/OE/36/3000	M08A04/FB4/BN/OE/41/3000	M08A04/FB4/BN/OE/46/3000
5.0M	3pins	0.25mm ²	M08A03/FB4/BN/OE/31/5000	M08A03/FB4/BN/OE/36/5000	M08A03/FB4/BN/OE/41/5000	M08A03/FB4/BN/OE/46/5000
	4pins	0.25mm ²	M08A04/FB4/BN/OE/31/5000	M08A04/FB4/BN/OE/36/5000	M08A04/FB4/BN/OE/41/5000	M08A04/FB4/BN/OE/46/5000
7.5M	3pins	0.25mm ²	M08A03/FB4/BN/OE/31/7500	M08A03/FB4/BN/OE/36/7500	M08A03/FB4/BN/OE/41/7500	M08A03/FB4/BN/OE/46/7500
	4pins	0.25mm ²	M08A04/FB4/BN/OE/31/7500	M08A04/FB4/BN/OE/36/7500	M08A04/FB4/BN/OE/41/7500	M08A04/FB4/BN/OE/46/7500
10M	3pins	0.25mm ²	M08A03/FB4/BN/OE/31/10M0	M08A03/FB4/BN/OE/36/10M0	M08A03/FB4/BN/OE/41/10M0	M08A03/FB4/BN/OE/46/10M0
	4pins	0.25mm ²	M08A04/FB4/BN/OE/31/10M0	M08A04/FB4/BN/OE/36/10M0	M08A04/FB4/BN/OE/41/10M0	M08A04/FB4/BN/OE/46/10M0

Specification

Number of contacts	3	4
Rated voltage	50V AC / 60V DC	
Rated current (40°C)	3A	
Protection degree	IP67/IP68	
Operating temperature	-25°C ~ +80°C	
Cable OD	4.6mm	4.6~5.0mm

Male cable (90° with shield)

Product figure



Scale diagram

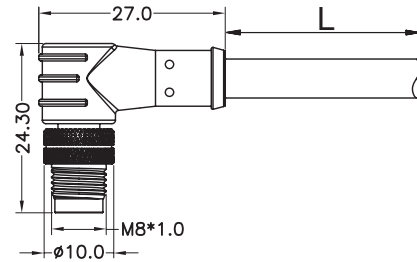

Contact layout (Front view)

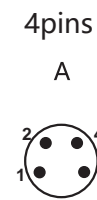

Circuit diagram

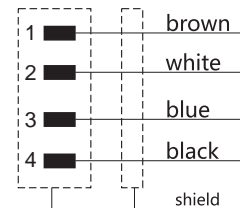
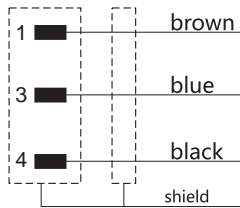

Order No

Cable length	Contacts	Wire diameter	PVC+AEB		PUR+AEB	
			black	gray	black	gray
1.5M	3pins	0.25mm ²	M08A03/MB5/BN/OE/31/1500	M08A03/MB5/BN/OE/36/1500	M08A03/MB5/BN/OE/41/1500	M08A03/MB5/BN/OE/46/1500
	4pins	0.25mm ²	M08A04/MB5/BN/OE/31/1500	M08A04/MB5/BN/OE/36/1500	M08A04/MB5/BN/OE/41/1500	M08A04/MB5/BN/OE/46/1500
3.0M	3pins	0.25mm ²	M08A03/MB5/BN/OE/31/3000	M08A03/MB5/BN/OE/36/3000	M08A03/MB5/BN/OE/41/3000	M08A03/MB5/BN/OE/46/3000
	4pins	0.25mm ²	M08A04/MB5/BN/OE/31/3000	M08A04/MB5/BN/OE/36/3000	M08A04/MB5/BN/OE/41/3000	M08A04/MB5/BN/OE/46/3000
5.0M	3pins	0.25mm ²	M08A03/MB5/BN/OE/31/5000	M08A03/MB5/BN/OE/36/5000	M08A03/MB5/BN/OE/41/5000	M08A03/MB5/BN/OE/46/5000
	4pins	0.25mm ²	M08A04/MB5/BN/OE/31/5000	M08A04/MB5/BN/OE/36/5000	M08A04/MB5/BN/OE/41/5000	M08A04/MB5/BN/OE/46/5000
7.5M	3pins	0.25mm ²	M08A03/MB5/BN/OE/31/7500	M08A03/MB5/BN/OE/36/7500	M08A03/MB5/BN/OE/41/7500	M08A03/MB5/BN/OE/46/7500
	4pins	0.25mm ²	M08A04/MB5/BN/OE/31/7500	M08A04/MB5/BN/OE/36/7500	M08A04/MB5/BN/OE/41/7500	M08A04/MB5/BN/OE/46/7500
10M	3pins	0.25mm ²	M08A03/MB5/BN/OE/31/10M0	M08A03/MB5/BN/OE/36/10M0	M08A03/MB5/BN/OE/41/10M0	M08A03/MB5/BN/OE/46/10M0
	4pins	0.25mm ²	M08A04/MB5/BN/OE/31/10M0	M08A04/MB5/BN/OE/36/10M0	M08A04/MB5/BN/OE/41/10M0	M08A04/MB5/BN/OE/46/10M0

Specification

Number of contacts	3	4
Rated voltage	50V AC / 60V DC	
Rated current (40°C)	3A	
Protection degree	IP67/IP68	
Operating temperature	-25°C ~ +80°C	
Cable OD	4.6mm	4.6~5.0mm

Female cable (90° with shield)

Product figure



Scale diagram

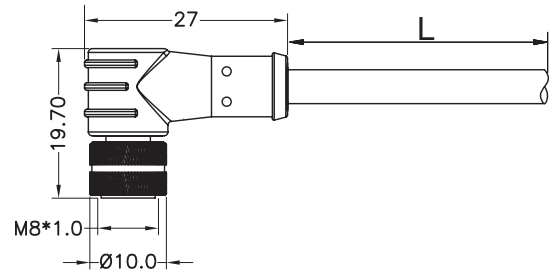

Contact layout (Front view)

3pins

A

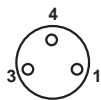

4pins

A

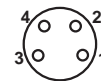

Circuit diagram

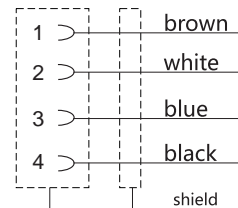
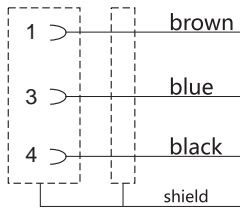

Order No

Cable length	Contacts	Wire diameter	PVC+AEB		PUR+AEB	
			black	gray	black	gray
1.5M	3pins	0.25mm ²	M08A03/FB5/BN/OE/31/1500	M08A03/FB5/BN/OE/36/1500	M08A03/FB5/BN/OE/41/1500	M08A03/FB5/BN/OE/46/1500
	4pins	0.25mm ²	M08A04/FB5/BN/OE/31/1500	M08A04/FB5/BN/OE/36/1500	M08A04/FB5/BN/OE/41/1500	M08A04/FB5/BN/OE/46/1500
3.0M	3pins	0.25mm ²	M08A03/FB5/BN/OE/31/3000	M08A03/FB5/BN/OE/36/3000	M08A03/FB5/BN/OE/41/3000	M08A03/FB5/BN/OE/46/3000
	4pins	0.25mm ²	M08A04/FB5/BN/OE/31/3000	M08A04/FB5/BN/OE/36/3000	M08A04/FB5/BN/OE/41/3000	M08A04/FB5/BN/OE/46/3000
5.0M	3pins	0.25mm ²	M08A03/FB5/BN/OE/31/5000	M08A03/FB5/BN/OE/36/5000	M08A03/FB5/BN/OE/41/5000	M08A03/FB5/BN/OE/46/5000
	4pins	0.25mm ²	M08A04/FB5/BN/OE/31/5000	M08A04/FB5/BN/OE/36/5000	M08A04/FB5/BN/OE/41/5000	M08A04/FB5/BN/OE/46/5000
7.5M	3pins	0.25mm ²	M08A03/FB5/BN/OE/31/7500	M08A03/FB5/BN/OE/36/7500	M08A03/FB5/BN/OE/41/7500	M08A03/FB5/BN/OE/46/7500
	4pins	0.25mm ²	M08A04/FB5/BN/OE/31/7500	M08A04/FB5/BN/OE/36/7500	M08A04/FB5/BN/OE/41/7500	M08A04/FB5/BN/OE/46/7500
10M	3pins	0.25mm ²	M08A03/FB5/BN/OE/31/10M0	M08A03/FB5/BN/OE/36/10M0	M08A03/FB5/BN/OE/41/10M0	M08A03/FB5/BN/OE/46/10M0
	4pins	0.25mm ²	M08A04/FB5/BN/OE/31/10M0	M08A04/FB5/BN/OE/36/10M0	M08A04/FB5/BN/OE/41/10M0	M08A04/FB5/BN/OE/46/10M0

Specification

Number of contacts	3	4
Rated voltage	50V AC / 60V DC	
Rated current (40°C)	3A	
Protection degree	IP67/IP68	
Operating temperature	-25°C ~ +80°C	
Cable OD	4.6mm	4.6~5.0mm

Male cable (with shield)

Product figure EtherCAT



Scale diagram

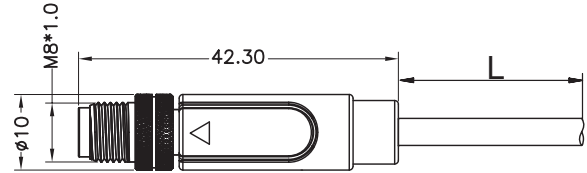

Contact layout (Front view)

4pins

A



Circuit diagram

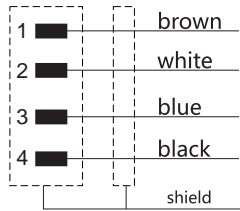

Order No/订货号

Cable length	Contacts	Wire diameter	PUR+AEB
			green
1.0M	4pins	0.15mm ²	M08A04/MB4/BN/OE/55/1000
1.5M	4pins	0.15mm ²	M08A04/MB4/BN/OE/55/1500
3.0M	4pins	0.15mm ²	M08A04/MB4/BN/OE/55/3000
5.0M	4pins	0.15mm ²	M08A04/MB4/BN/OE/55/5000
7.5M	4pins	0.15mm ²	M08A04/MB4/BN/OE/55/7500
10M	4pins	0.15mm ²	M08A04/MB4/BN/OE/55/10M0

Specification

Number of contacts	4
Rated voltage	50V AC / 60V DC
Rated current (40°C)	3A
Protection degree	IP67/IP68
Operating temperature	-25°C ~ +80°C
Cable OD	4.6~5.0mm

Male cable (90° with shield)

Product figure EtherCAT



Scale diagram

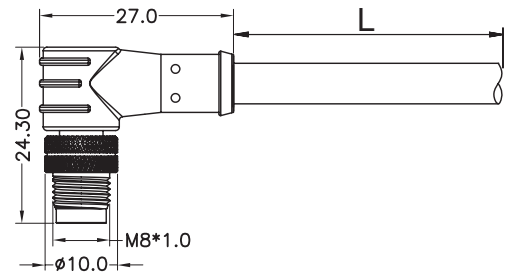

Contact layout (Front view)

4pins

A



Circuit diagram

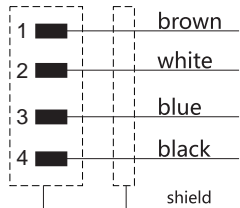

Order No

Cable length	Contacts	Wire diameter	PUR + AEB
			green
1.0M	4pins	0.15mm ²	M08A04/MB5/BN/OE/55/1000
1.5M	4pins	0.15mm ²	M08A04/MB5/BN/OE/55/1500
3.0M	4pins	0.15mm ²	M08A04/MB5/BN/OE/55/3000
5.0M	4pins	0.15mm ²	M08A04/MB5/BN/OE/55/5000
7.5M	4pins	0.15mm ²	M08A04/MB5/BN/OE/55/7500
10M	4pins	0.15mm ²	M08A04/MB5/BN/OE/55/10M0

Specification

Number of contacts	4
Rated voltage	50V AC / 60V DC
Rated current (40°C)	3A
Protection degree	IP67/IP68
Operating temperature	-25°C ~ +80°C
Cable OD	4.6 ~ 5.0mm



Engelking Elektronik GmbH

Albstraße 16
D-78609 Tuningen

Tel.: +49 (0)7464 9865 0
Fax: +49 (0)7464 9865 71
E-Mail: info@engelking.de

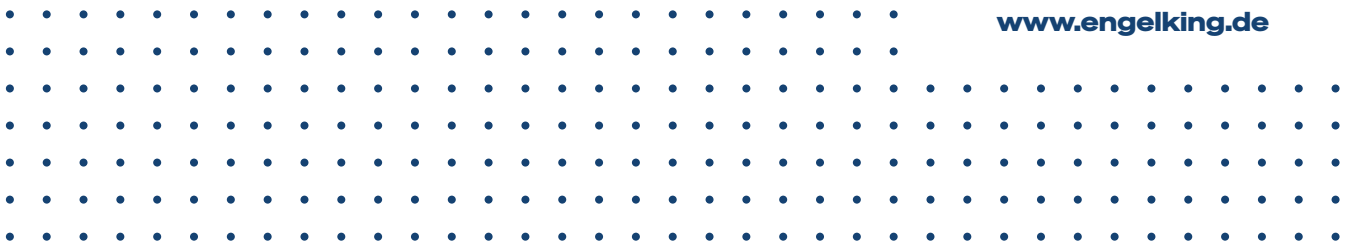

www.engelking.de